

## Effect of Temperature and Nickel Concentration on the Electrical and Dielectric Properties of Polyethylene-Nickel Composites

Ghassan Adnan Naeem

Physics Department, College of Education for Pure Science, AL-Anbar University, Anbar/Ramady, Iraq

---

**Abstract:-** In this paper the effect of temperature range of 298 K to 348 K and volume filler content  $\phi$  on electrical properties of polyethylene PE filled with nickel Ni powders has been investigated. The volume electrical resistivity  $\rho_v$  of such composites decreases suddenly by several orders of magnitude at a critical volume concentration (i.e.  $\phi_c=14.27$  Vol.%) ,whereas the dielectric constant  $\epsilon'$  and the A.C electrical conductivity  $\sigma_{AC}$  of such composites increase suddenly at a critical volume concentration (i.e.  $\phi_c=14.27$  Vol.%). For volume filler content lower than percolation threshold  $\phi < \phi_c$  the resistivity decreases with increasing temperature, whereas the dielectric constant and the A.C electrical conductivity of such composites increase indicating a semi-conducting behavior, where for  $\phi > \phi_c$  there is increase in the value of their resistivity, and decrease in the value of their dielectric constant and the A.C electrical conductivity  $\sigma_{AC}$  with increasing temperature indicating metallic-conduction.

**Keywords:-** conducting polymer, filler, polymer matrix, polyethylene, CPCPM, percolation threshold.

---

### I. INTRODUCTION

In our daily life we are surrounded by more and more articles produced of polymers rather than traditional materials such as wood, metals or ceramics. One of the main drivers contributing to the popularization of polymers is their ease of processing into complexly shaped parts at high speeds and low costs via relatively simple processes, such as extrusion, injection and compression modelling. Complementary advantages of polymers are their low density and large range of specific properties due to these properties polymers are becoming attractive. Conducting polymer composite materials (CPCPM), that consist of a random distribution of a conducting filler throughout an insulating polymer, deserve interest in several application fields [2]. They have emerged as a new group of engineering materials lately. Possible applications include (a) discharging static electricity, (b) heat conduction, (c) electrical shielding, (d) converting mechanical to electrical signals, (f) absorbing electrical waves, and (g) friction-antifricition materials. The materials are likely to have the following advantages in comparison with metals: high corrosion resistance, lower specific weight, ease of workability when manufacturing products of complex shapes are desired, cheapness, and great accessibility [3].

The purpose of use of fillers can be divided into two basic categories, first, to improve the properties of the material and second, to reduce the cost of component. Metal-polymer composites are a relative new of technological materials; their electrical characteristics are close to those of metals, whereas the mechanical properties and processing methods are typical for plastics. The conditions of electric charge transfer determine the electrical conductivity level and the dielectric properties of the heterogeneous system, in which polymer forms the matrix and conductive phase is formed by the dispersed metallic filler. The electrical properties of (CPCPM) depend on several factors, including the kind of conducting filler, the spatial distribution of filler particles, the interaction between polymer and filler, and the contact interaction between particles [4]. By gradually increasing the filler content in a metal-polymer composite, the most significant changes in electrical and dielectric properties occur in a certain, relatively narrow critical region of filler content  $\Phi_c$  (percolation concentration). Usually the percolation model is used for explaining the observed effects in metal-polymer composite[5].

The percolation theory is the most adequate for modelling conductivity of CPCPM. It involves convergence of particles to distances at which the probability of transfer of current carriers between them becomes higher than zero. The so-called percolation threshold  $\phi_c$ , i.e. the lowest concentration of conduction particles at which continuous conducting chains are formed, is easily determined from the experimental dependence of conductivity on the filler concentration. It is a very useful tool to probe the filler distribution within a polymer matrix [6].

Increased attention has been paid in recent years to the researches on polymeric composites in general and PE- metal composite in particular. A brief summary of various experimental studies on PE- metal composite is given below. Turner and co-workers [6-9] reported early works on polyethylene-Ni composites. They made

---

preliminary investigations on polyethylene-Ni and polyurethane-Ni systems. Their studies showed that the critical composition of metal could be reduced considerably by segregation of the metallic particles. Segregation was effected by admixture of large particles of polymer with smaller particles of metal followed by compaction. Horibe et-al [10] investigated the effect of the content and particle size of carbon black filler on the electrical conductivity of the PE-C.B composite .the study of composites showed that the resistivity of PE-C.B composites decreased with increasing C.B content, and the smaller the C.B. particle size is the lower resistivity of the PE-C.B composites. Ismail [11] studied the electrical resistivity and tensile properties of composites formed by the incorporation of metal such as Al, Cu & Fe in PE matrix. It is found that the electrical resistivity of the composites is governed by the shape of filler and amount of filler content.

The aim of this paper is to focus on study of the effect of filler concentration and the effect of temperature on the electrical properties of PE-Ni composites. It is important from the practical point of view because composites are used extensively in many industrial applications.

## II. EXPERIMENTAL PART

### 1. Materials

**The materials used in this work were:**

**a.** High-density polyethylene is used as polymer matrix, a non polar polymer. It is light polymer with a density approaching 0.95-0.97 gm/cm<sup>3</sup>. Polyethylene is commercially available , the commonly used polyethylene due to its ability for modelling in various ways and tempting properties such as high density, good mechanical properties, good dielectric in high frequency and possesses a good resistance against corrosion because it is inert against chemicals . Its chemical formula is shown in the following [12]:

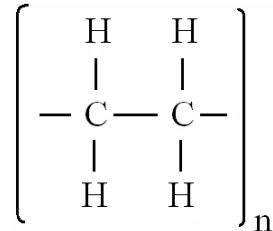

**b.** Nickel powder from (Metco Ltd. England) of particle size 75-100 microns with a density 8.902 gm/cm<sup>3</sup>.

### 2. Preparation of PE-Ni composites

Weighed amounts of polyethylene and nickel powders were mixed by a rotary blender until a homogeneous product was obtained. The mixture was compacted in steel cylindrical of diameter 3 cm under a pressure of 110 bar for 10 min at 110°C, the die was then cooled to 50°C by tapped water. The compacted sample was ejected from the die and allowed to cool to room temperature. The specimens were modelled in disc-shape with a diameter of about 30 mm and a thickness ranged between 0.9 and 1.5 mm. Table1 gives the list of weight percentage of all the PE-Ni specimens and their equivalent volume percentage. The weight percentage of Ni powder is given by:

$$wt.\% \text{ of Ni} = \frac{W_{Ni}}{W_T} \times 100\% \dots\dots\dots(1)$$

Whereas The weight percentage of PE powder is:

$$wt.\% \text{ of PE} = \frac{W_{PE} - W_{Ni}}{W_T} \times 100\% \dots\dots(2)$$

Where  $W_T$  : the total weight of sample,  $W_{Ni}$  : weight of Ni powder and  $W_{PE}$  : weight of PE powder .The volume percentage of Ni powder is given by:

$$Vol.\% \text{ of Ni} = \frac{W_{Ni}/D_{Ni}}{W_{PE}/D_{PE}} \times 100\% \dots\dots(3)$$

Where  $D_{Ni}$  : density of Ni powder and  $D_{PE}$  : density of PE powder.

**Table I:** List of weight percentage of all the PE-Ni specimens and their equivalent volume percentage.

### 3. Optical Micrograph

All samples of PE-Ni composites were examined by the optical microscope from (Olympus – BH-22) which have a maximum magnification power of (  $\times 500$  ) and equipped with light intensity automatic controlled camera.

**4. Measurement of DC electrical properties**

The resistivity data were obtained with specimens shaped according to ASTM, D257- 66 standard. Figure.1a by means of the Three electrodes arrangement [13].This technique has been used to decrease the effect of the fringing of the electric field at edges ,and to distinguish between the surface and the volume resistivity of the sample ,therefore it permits measuring the bulk resistivity of the material.

Symbol of sample	Weight percentage of the filler	Volume percentage of the filler
$\phi_1$	15	<b>1.63</b>
$\phi_2$	25	<b>3.09</b>
$\phi_3$	35	<b>4.99</b>
$\phi_4$	55	<b>11.33</b>
$\phi_5$	65	<b>17.22</b>
$\phi_6$	<b>70</b>	<b>21.63</b>

In Figure1b a schematic representation of the preferential current paths and the equivalent electric circuit are shown . $R_s$  represent the surface resistance between the guard and the guarded electrodes , $R_v$  the volume resistance between the guarded and the bottom electrodes ,and  $R_g$  is the guard resistance between the guard and the bottom electrodes.

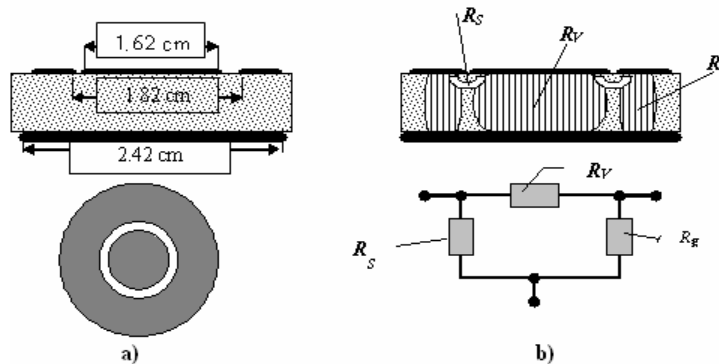

**Fig. 1: (a) Shape of the specimen and of the electrodes. (b) Schematic representation of the preferential current paths and equivalent electric circuit.**

The complete system of the D.C. volume resistivity measurement is shown in Figure 2. The electrodes were made of copper metal, and a uniform pressure on the specimen was applied by Four adjustable screws, the electrical input was provided by means of stabilized D.C. power supply (Philip Harris Limited) which provide an output voltage from 0 to 3000 volt .The output current was measured by Keithley 616C / digital solid state electrometer.

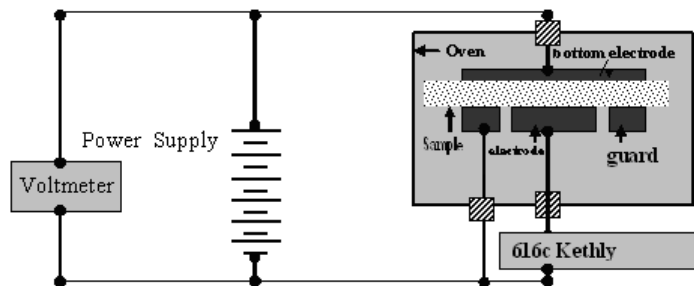

**Fig. 2: Schematic diagram of the DC volume resistivity measurements.**

The Keithley electrometer provides direct reading current ranges to  $10^{-12}$  ampere full scale. The test samples are in the form of disc like shape, the disc surfaces were covered by a (AL) leaf to ensure uniform electrical contact and to minimize the contact resistance. The test sample is placed between the two electrodes and left at a desired temperature for half hour, then the desired test voltage is selected from the voltage supply and the current passing through the bulk of the test sample at this selected temperature, is measured by the electrometer. The volume resistivity measurements were performed in the temperature range between 298 K – 348 K by using a temperature controlled oven (MLW) which has been shield against external electromagnetic field.

### 5. Measurement of AC electrical properties

Figure 3 shows the guard electrode specimen holder which is situated in temperature controlled oven (MLW). As shown in the figure, the high and low specimen holder terminals are connected to Multi-Frequency LCR Meters (Models *hp-4274A* & *hp-4275A*), and the third specimen holder terminal is connected to earth. The *hp-4274A* & *hp-4275A* are able to measure several parameters among them, the specimen capacitance  $C$ , dissipation factor  $\tan \delta$ , and the phase angle  $\phi$ . The HP covers a frequency range of 100Hz to 10MHz. In this paper we use only 1KHz because the dielectric constant is generally insensitive to the frequency increasing in the low and intermediate frequency range for non polar polymers[14].

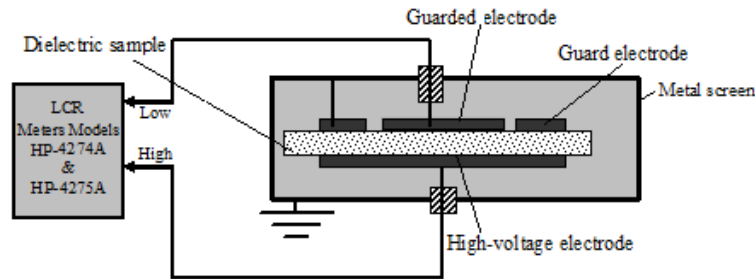

Fig. 3: Schematic diagram for the A.C. measurements.

All the wiring was shielded to reduce the noise which is readily detectable especially in case of high resistance measurements.

## III. RESULTS AND DISCUSSION

Figure 4 shows the optical micrographs of different composites. At 1.63 Vol. % and 3.09 Vol. % (fig.4a, 4b), the Ni particles are randomly distributed and the matrix in whose lattice sites are made of metallic and no metallic particle sites, this means that if two metallic particles are at neighbouring lattice sites, there is interaction, but if they are separated by at least, one non-metallic particle, there is no interaction. At 11.33 Vol. % (fig.4c), the concentration of filler sites is slightly below the threshold value, the Ni particles tend to form conductive network so that a finite clusters are existed. At 17.22 Vol. % and 21.63 Vol. % (fig.4d, 4e), the conductive network have been form by touching conductive particles, the conductive network consists of infinite chains of interconnected sites.

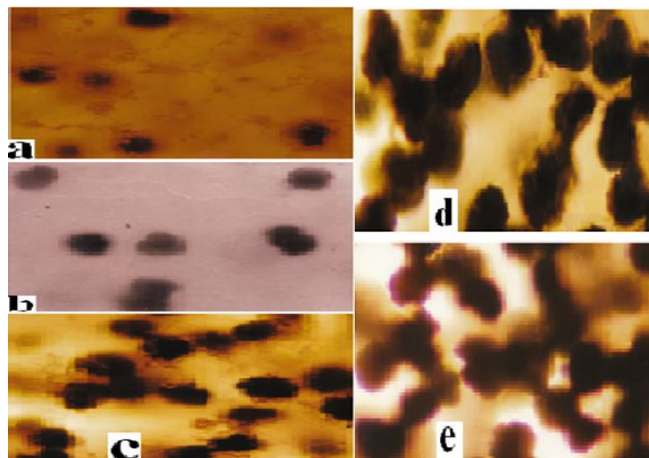

Fig. 4: Photomicrographs of PE-Ni composites ( $\times 100$ ):

(a) 1.63 Vol. %, (b) 3.09 Vol. %, (c) 11.33 Vol. %, (d) 17.22 Vol. % & (e) 21.63 Vol. %.

**A. D.C. Electrical Resistivity Results**

The volume resistance for composites of various volume filler concentrations (0, 1.63,3.09,4.99,11.33, 17.22 and 21.63 Vol. %) were measured during heating by the guard ring electrode method. The volume resistivity  $\rho_v$  was determined from the equation [15]:

$$\rho_v = R_v \frac{A}{L} \dots\dots\dots(4)$$

Where  $R_v$  is the volume resistance between the guarded and the bottom electrodes in ohm measured as the ratio between desired applied test voltage and the current passing through the test sample,  $L$  is the average thickness of the sample;  $A$  is the guarded electrode effective area.

Figure 5 shows the electrical resistivity enhancement of the composite by increasing the volume filler concentration of the nickel filler at (T=298 k).

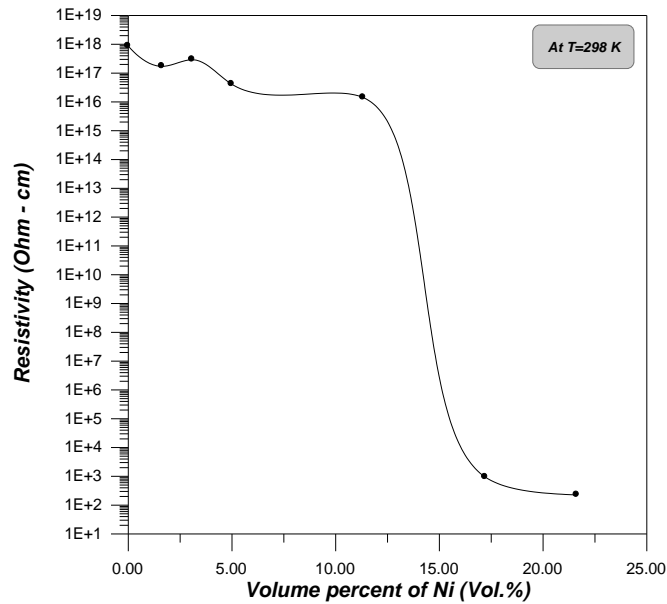

**Fig. 5: The volume electrical resistivity,  $\rho_v$ , of PE-Ni composites as a function of Ni concentration.**

At lower concentration of the filler [0, 1.63,3.09,4.99,11.33vol.% <  $\Phi_c=14.27$  Vol.%], the electrical resistivity of the composite decreases slightly; while at higher concentrations[ $\Phi_c=14.27$  Vol.% < 17.22 ,21.63 Vol.% ], the resistivity decreases sharply where the composite becomes a good conductive substance. The slight decrease in resistivity may be due to the space charge effect caused by the addition of a small amount of nickel filler, in addition to the matrix impurities existing in the used commercial polyethylene. At high filler content [17.22 21.63 Vol.%], the amount of the interconnecting networks is increased ( see figures.4d, 4e) and the contact resistance between the filler is decreased, and hence a good electron conduction is achieved resulting in transformation of the polymer insulator to a good conductive polymer composite.

Figure 6 shows the variation of the electrical resistivity of various prepared composites over a temperature range of 298 K to 348 K .At filler concentrations [0, 1.63,3.09,4.99,11.33Vol.% <  $\Phi_c=14.27$  Vol.%], the resistivity of the substance is high and decreases with increasing temperature, i.e. the temperature coefficient of resistance is negative, similar to typical semiconductors. For specimens highly concentrated with nickel filler[17.22 ,21.63 Vol.% >  $\Phi_c=14.27$  Vol.%], the resistivity increases slightly over the testing temperature range and the temperature coefficient of resistance becomes positive, similar to typical metals .As a summary of the thermal behavior of resistivity of the composites, we can say that the observed decrease of the resistivity of low filler content specimens with temperature results from two contributions in the conduction mechanism .The first one is hopping that arises from the space charge effect in the contact regions because of the presence of free ions in commercial polymers, and the second is the addition of a small amount of nickel filler. The slight increase of the electrical resistivity of highly filler composites with temperature indicates a metallic-type conduction mechanism due to conductive networks, where the thermal expansion and result in increasing resistivity with temperature effects cause a reduction in contacts between the fillers in the network[7].

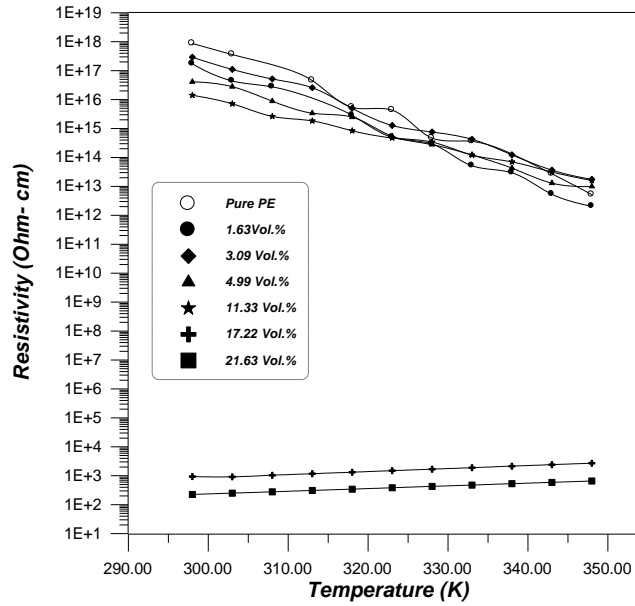
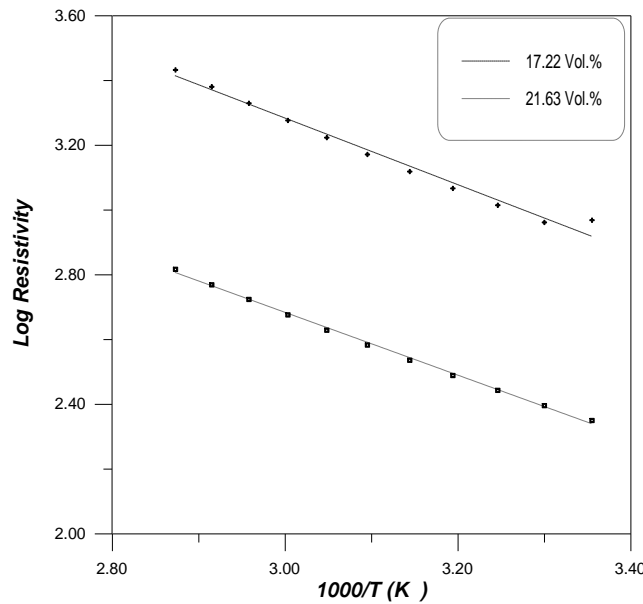

**Fig. 6: The volume electrical resistivity,  $\rho_v$ , of PE-Ni composites as a function of temperature.**

Figures 7&8 show the relation of  $\text{Log } \rho_v$  against the reciprocal temperature, from the slopes of best fit of these curves the activation energy  $E_a$  for PE-Ni specimens can be calculated by using the equation [16]:

$$\rho_v = \rho_0 \exp\left(-\frac{E_a}{RT}\right) \dots \dots \dots (5)$$

Where  $\rho$  is the measured electrical resistivity,  $\rho_0$  is constant, R is the universal gas constant, and T is the absolute temperature.



**Fig. 7: Variation of the volume electrical resistivity,  $\rho_v$ , with reciprocal temperature for PE specimens of low and medium Ni concentration (i.e.  $\phi < \phi_c$ ).**

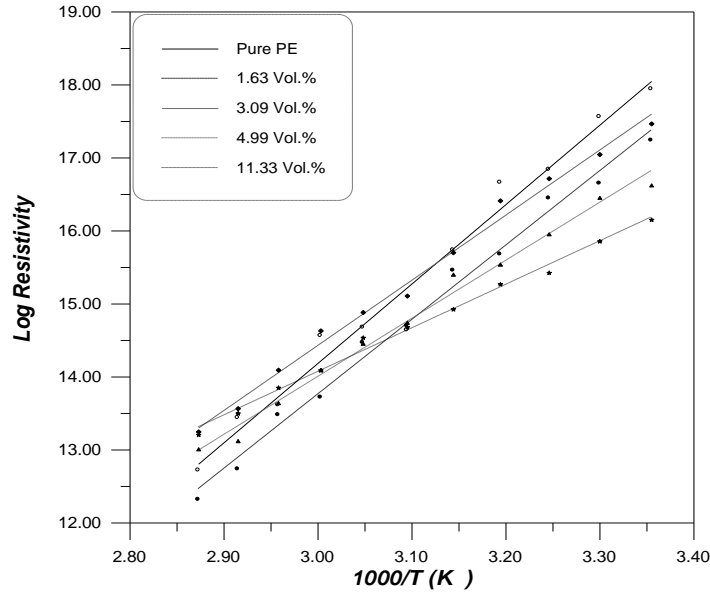

**Fig.8: Variation of the volume electrical resistivity,  $\rho_v$ , with reciprocal temperature for PE specimens of high nickel concentration (i.e. 17.22 & 21.63 Vol.%).**

Figure 9 shows the variation of the activation energy and filler content, that  $E_a$  decreases rapidly with the filler concentration of composites. The  $E_a$  of the thermal activated rate process decreases from about 21.44 KCal.mol<sup>-1</sup> (typical for polymers) to about 1.92 KCal. mol<sup>-1</sup> (typical for conductive or semi-conductive composites). The same effect has been reported by some researchers [16,17].

It can be seen from Figure 9 that there are mainly three different trends of behavior of the bulk resistance with temperature and filler content. These three trends correspond physically to different electrical conduction process occurring in the polymer composite and depend on their modified structure. One process with specimens low filler concentrations [0,1.63,3.09,4.99 vol.% <  $\Phi_c=14.27$  Vol.%] which have high activation energy value [21.44 KCal.mol<sup>-1</sup>, 20.2 KCal.mol<sup>-1</sup>, 17.32 KCal.mol<sup>-1</sup> & 14.84 KCal.mol<sup>-1</sup>] result from the existence of large resistance contact gives the composites more insulating behavior. The second process with specimen's medium filler concentration [11.33 vol. % <  $\Phi_c=14.27$  Vol.%] which have medium activation energy value [12.11 KCal.mol<sup>-1</sup>] arises from the hopping mechanism. While the third process with specimens high filler concentration [17.22, 21.63 Vol. % >  $\Phi_c=14.27$  Vol.%] which have low activation energy value [2.16 KCal.mol<sup>-1</sup>, 1.92 KCal.mol<sup>-1</sup>] result from a metallic-type conduction mechanism due to conductive networks, a case which reflects that a new conductive polymer composite is constructed from the insulating polymer polyethylene.

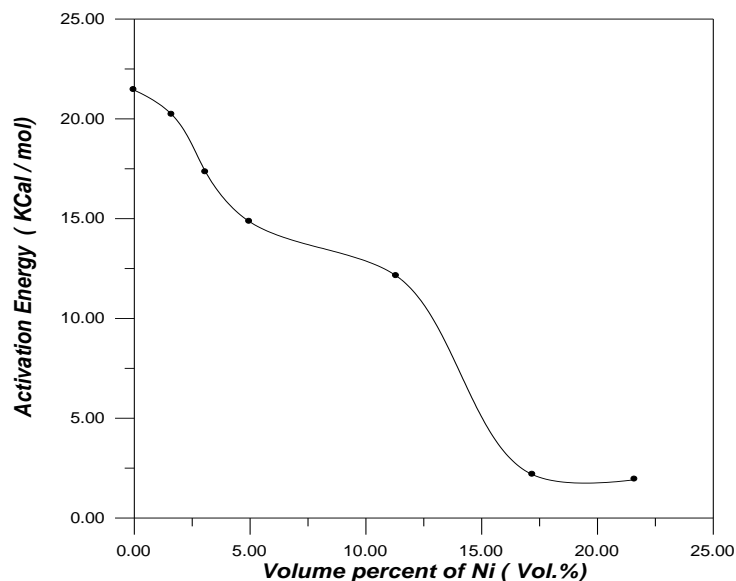

**Fig. 9: Variation of the activation energy,  $E_a$ , of PE-Ni composites with the filler concentration.**

**B. A.C. Electrical Conductivity Results**

The Variation of dielectric constant,  $\epsilon'$ , as function of nickel concentration and temperature is shown in figure 10. The values of the real component,  $\epsilon'$ , were calculated from the equation [18]:

$$\epsilon' = \frac{C}{C_o} \dots\dots\dots (6)$$

When the nickel concentration is below the threshold value (i.e. 0, 1.63, 3.09, 4.99, 11.33 vol.% <  $\Phi_c=14.27$  Vol.%) the,  $\epsilon'$ , values are low, characteristics of dielectric behaviours, the figure show that the,  $\epsilon'$ , value in first and second doped specimens are slightly lower than that of pure material. This could be attributed to oxidation effect, which may be eliminated in higher nickel concentration. Increasing the nickel concentration results in increasing the average number of contacts among the nickel conductive particles which results increasing,  $\epsilon'$ , value. When Ni concentration equal or above the threshold value ( $\Phi_c=14.27$  Vol.%) dielectric constant of very high value approaching infinity, This case can be explained by Bruggeman's [16] formula, when Ni concentration equal or above the threshold value ( $\Phi_c=14.27$  Vol.%) the long chain emerging through connecting nickel particles will be formed, i.e. One cluster consisting of infinite number of metal particle will be formed., the  $\phi$  value in this case will be approaching One ( $\phi \approx 1$ ), when substituting the  $\phi$  value in the Bruggeman's formula:

$$\left\{ \epsilon' = \frac{\epsilon_1}{(1-\phi)^3} \approx \frac{\epsilon_1}{(1-1)^3} \approx \infty \right\} \dots\dots\dots (7)$$

(where  $\epsilon_1$  is the permittivity of the matrix) ,this makes dielectric constant of very high value approaching infinity. Looking back to the figure(10) the effect of increasing temperature on the  $\epsilon'$  value is shown. Heating up the specimens result in slightly increasing  $\epsilon'$  value of specimens of nickel concentration below the threshold value ( $\Phi_c=14.27$  Vol.%) ,characteristics of semiconductor-type behaviours. Whereas for specimens Ni concentration equal or above the threshold value ( $\Phi_c=14.27$  Vol.%) the,  $\epsilon'$ , values are decreased with increasing temperature are characteristics of metallic-type behaviours.

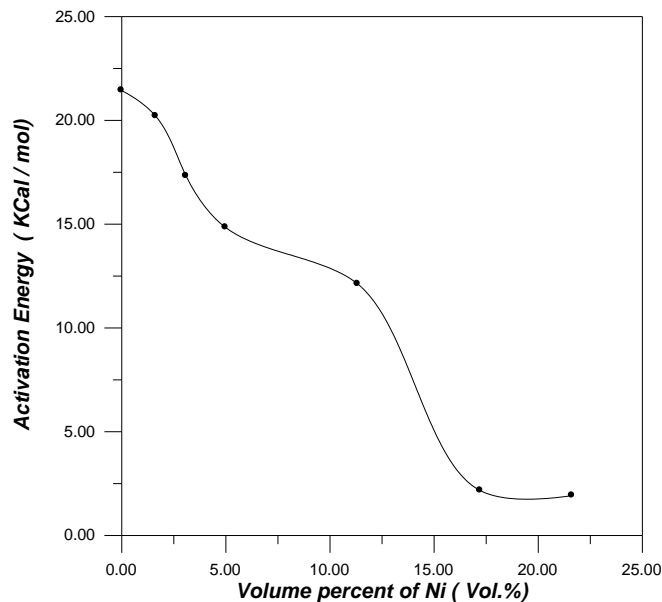

**Fig.10: Variation of the activation energy,  $E_a$ , of PE-Ni composites with the filler concentration.**

The variation of A.C electrical conductivity,  $\sigma_{AC}$ , as function of the volumetric filler content of PE-Ni composites in temperature range from 298 K to 348 K is shown in figure 11, The data were calculated from the equation :

$$\sigma_{AC} = 2\pi f \epsilon_o \epsilon'' \dots\dots\dots (8)$$



Where  $\epsilon_0$  is the permittivity of free space {  $\epsilon_0 = 8.854 \times 10^{-12}$  F. m<sup>-1</sup>},  $f$  is the frequency and  $\epsilon''$  is dielectric loss.

$$\epsilon'' = \epsilon' \cdot \tan \delta \dots\dots\dots(9)$$

Where  $\tan \delta$  is loss angle  $\delta$  [18].

The A.C conductivity,  $\sigma_{AC}$ , of PE-Ni composites is increased slightly when the filler concentration is below threshold value (i.e.  $\Phi_c=14.27$  Vol.%), this behavior can be explained by the polarization effect and hopping, i.e. a polarization effect since the nickel concentration is insufficient to form an infinite conducting network, i.e. the polarization between these finite networks (clusters) as well as the hopping of the electron between adjacent states, randomly distributed within these finite network. Whereas for specimens Ni concentration equal or above the threshold value  $\Phi_c$  the A.C conductivity,  $\sigma_{AC}$ , increases sharply with increasing the filler concentration. This increase in the A.C conductivity,  $\sigma_{AC}$ , could be attributed possibly to the formation of continues conducting cluster, hence a good electron conduction is achieved between the metal particles. The behavior of the A.C conductivity,  $\sigma_{AC}$ , as function of temperature through heating can characterized by two kinds. The first kind occur at low filler concentration, the A.C conductivity,  $\sigma_{AC}$ , of samples is low essentially, of insulating polymer, and increase slowly with increasing temperature. The second kind at higher nickel concentration, the A.C conductivity,  $\sigma_{AC}$ , decreases slightly over the testing temperature range.

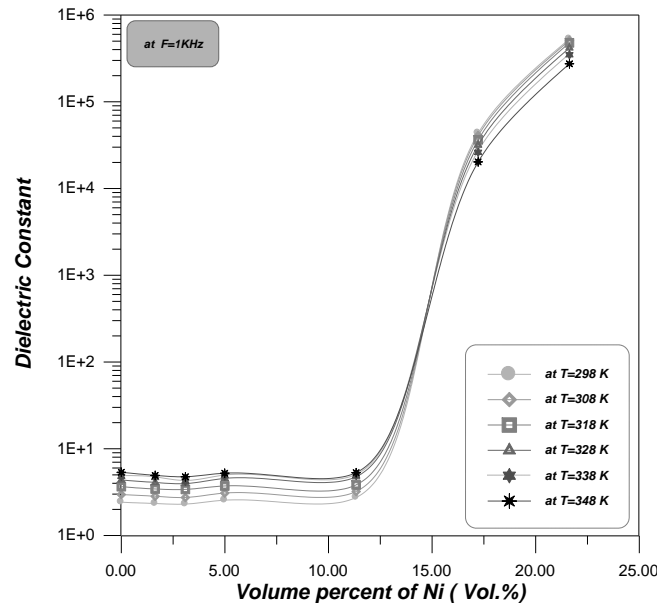

Fig.10: Variation of dielectric constant,  $\epsilon'$ , of PE-Ni composites with the filler concentration & temperature at F=1KHz .

#### IV. CONCLUSIONS

From the results presented above the following conclusions may be drawn:

1. The electrical resistivity, dielectric constant and A.C conductivity of PE-Ni composites are enhanced by increasing the filler concentration.
2. The electrical resistivity of PE-Ni composites decrease suddenly by thirteen orders of magnitude from  $1.419 \times 10^{16} \Omega cm$  to  $9.332 \times 10^2 \Omega cm$  when the filler concentration reach the threshold value  $\Phi_c=14.27$  Vol.% .
3. The electrical resistivity, dielectric constant and A.C conductivity of PE-Ni composites showed temperature dependence in the range under investigation.
4. The calculated activation energy for the composites was found to decrease with increasing filler concentration
5. Addition of nickel filler alter the electrical conduction mechanism of PE-Ni composites.

## REFERENCES

- [1]. M.A.Kori, M.G.Kulthe & R.K.Goyal, "International J. of Innovative Research in Science, Engeneering and Technology" , vol.3,Issue 6,2014.
- [2]. F.Gubbels, S.Blacher, E.Vanlathem, R.Jerome, R.Veltoure, F.Broues & Ph.Teyssie,"Macromolecules", vol.28, pp .1559-1566, 1995.
- [3]. R.Mukhopay, S.K.De, S.Basu, "J.Appl.Polym.Sci.",vol.20, pp .2575,1976.
- [4]. Z. Zhou, S. Wang, Y. Zhang, & Yi. Zhang,,"J.Appl.Poly.Sci." , vol. 102 Issue5, pp .4823 – 4830, 2006.
- [5]. H.S. Dahiya, N. Kishore & R. M. Mehra , "J.Appl.Poly.Sci." , vol. 106 Issue3, pp .2101 -2110, 2007.
- [6]. Ye .P. Mameunya, Yv. V. Muzychenko, P.Pissis, E.V.Lebedev, & M. I. Shut , "Polymer Engineering and Science, 2002.
- [7]. A.Malliaris and D.T.Turner,"J.Appl.Phys." vol.42, pp .614, 1971.
- [8]. R.P.Kusy and D.T.Turner , "J.Appl.Polym.Sci.",vol.17 , pp .1631, 1973.
- [9]. J.E.Scheer and D.T.Turner , (1971), "SPE J.", vol .99, pp. 572.
- [10]. H.Horibe, T.Kamimura & K.Yoshida,,"Japa. J.of Appl. Phys." , vol .44, pp.2025-2029, 2005.
- [11]. H.Ismail, "J.of Thermopl. Compo. Mater." , vol .19, No.4, pp.413 -425, 2006.
- [12]. N.G. MCckum, C.P. Buckley and C.B. Bucknall , "Principles of Polymer Engineering", Second Ed., Oxford University Press, U.K., 1997.
- [13]. S.S.AL-Rawi, M.N.AL-Delaimi & G.A.Naeem AL-Heti , "J. College of Education for Women", vol.12, (3), 2001.
- [14]. H.F.Mark & N.G.Gaylord , "Encyclopedia of Polymer Science &Engineering",2nd,vol.5, pp.531, 1971.
- [15]. M.Z.Iqbal, G.M.Mamoor, Tariq Bashir,M.S. Irfan &M.B.Manzorr,"J. of Chemical Engineering, IEB", vol .CHE.25,No.1,2010.
- [16]. A.Hashim,A.Marza,B.H.Rabee,M.A.Habeeb,N.Abd-alkadhim,A.Saad Z.Alrarmadhan,"Chemistry and Materials Resaerch" , vol .3,No.7. , pp.40-43,2013.
- [17]. A.Hashim ,B.H.Rabee,M.A.Habeeb&N.Abd-alkadhim,"American J. of Scientific Research",Issue 74,pp.05-08,2012.
- [18]. V.Pan WAK,"European Polymer J." , vol .45,No.6. , pp.1777-1784,2009.